

Volume Capacity 1944.00 cu. in.
EPS 1.25 PCF

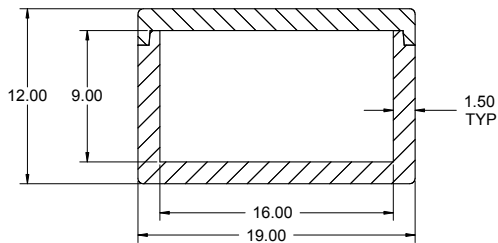

SECTION A-A

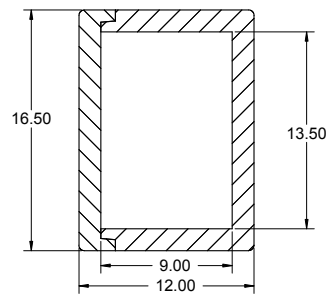
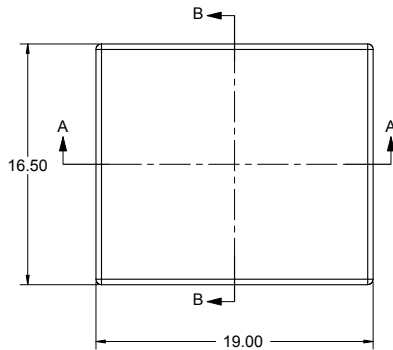
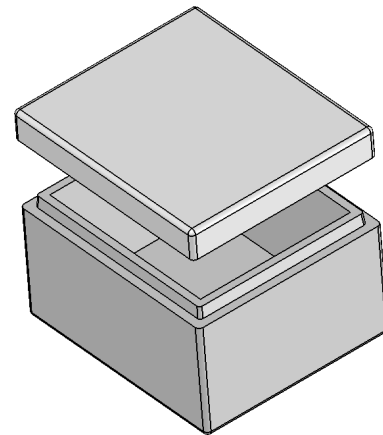

SECTION B-B